

AN·TRAX IT

GRIFFE

TREO

DESIGN ANDREA CROSETTA







Griffe / TREO

DESIGN ANDREA CROSETTA

203 x 39.8 cm

WATT ΔT 50° [424]

COLOR : BRAG

INFORMAZIONI TECNICHE / TECHNICAL DETAILS / DONNÉES
TECHNIQUES / TECHNISCHE DATEN / INFORMACIONES TÉCNICAS
PAGE 212

The simplicity of a flat surface is adorned with three aligned holes that make Treo a unique, truly unmistakable radiator.

La simplicité représentée par une surface plane décorée de trois trous alignés rendant le radiateur Treo unique et incomparable.

Drei aufeinanderfolgende Löcher zieren eine ebene Fläche und machen den Heizkörper Treo zu einem einzigartigen und unvergleichbaren Symbol der Schlichtheit.

La sencillez representada por una superficie plana se decora con tres agujeros alineados que convierten el radiador Treo en único e inconfundible.

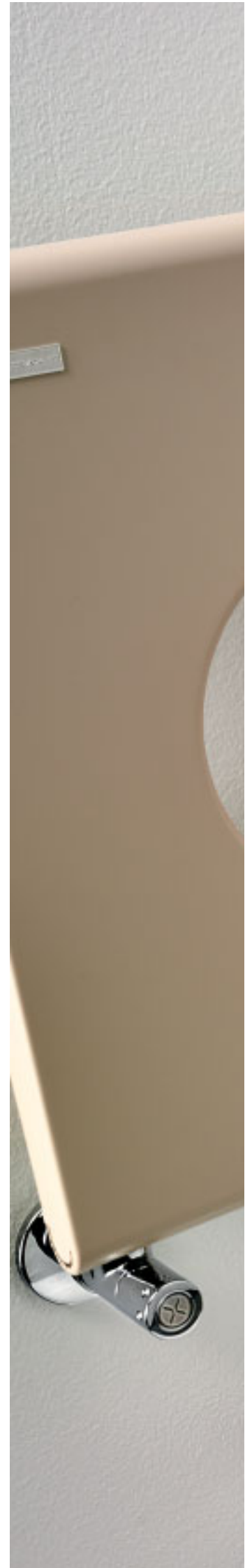





Griffe / TREO

DESIGN ANDREA CROSETTA

203 x 39,8 CM

WATT Δt 50° [479]

COLOR : TELA

INFORMAZIONI TECNICHE / TECHNICAL DETAILS / DONNÉES
TECHNIQUES / TECNISCHE DATEN / INFORMACIONES TÉCNICAS
PAGE 212





Treo DESIGN ANDREA CROSETTA

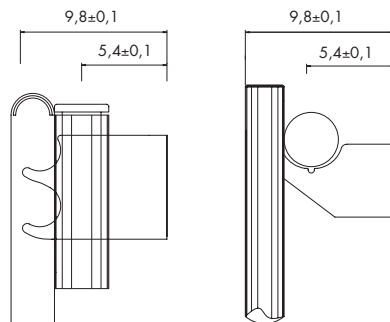
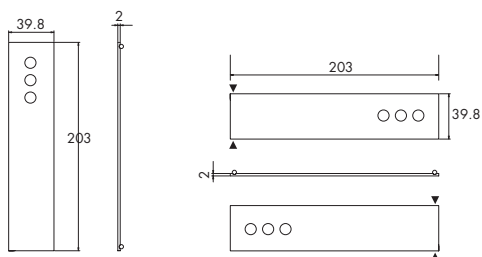

[X] attacco standard
standard connection
raccord standard
standard Anschluss
conexión estándar

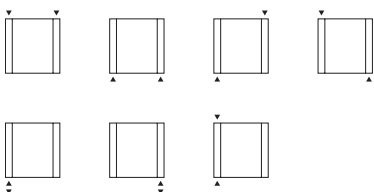

[X] attacco standard
standard connection
raccord standard
standard Anschluss
conexión estándar

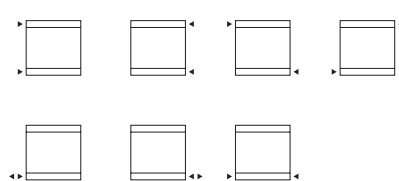

[B] attacco speciale
special connection
raccord spéciale
speziell Anschluss
conexión especial

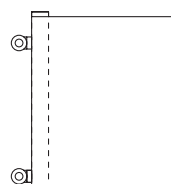

[B] attacco speciale
special connection
raccord spéciale
speziell Anschluss
conexión especial

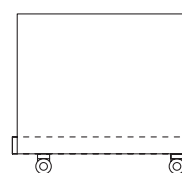

[B5] attacco interasse 5 cm
pipe centres 5 cm
raccords 5 cm
5 cm Achsabstand Anschluss
conexión entre ejes: 5 cm.

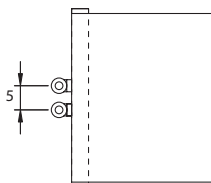

[B5] attacco interasse 5 cm
pipe centres 5 cm
raccords 5 cm
5 cm Achsabstand Anschluss
conexión entre ejes: 5 cm.

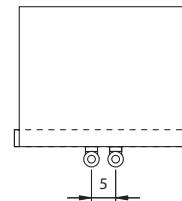

P* 296

P* 296

A* cm	in	B* cm	in	I* cm		I* cm		ari*	BTU Δt 50°	watt Δt 50°
verticale / vertical / verticale / vertikal / vertical										
203.0	79.9	39.8	15.7	45.8	18.0	196.0	72.2	TR25000S200010	1447	424
B* cm	in	A* cm	in	I* cm		I* cm		ari*	BTU Δt 50°	watt Δt 50°
orizzontale / horizontal / horizontale / horizontal / horizontal										
203.0	79.9	39.8	15.7	196.0	77.2	45.8	18.0	TH25000S200010	1635	479

A* = altezza / height / hauteur / Höhe / alto B* = larghezza / width / longueur / Breite / ancho art* = articolo / model / modèl / Artikel / artículo P* = pagina / page / page / Seite / página I* = interasse / pipe centres / distance entre depart et retour / Achsabstand / distancia entre las conexiones



Ulteriori dettagli
Further details
Ultérieures détails
Weitere Einzelheiten
Otros detalles

P* 294

Colori/ colours / couleurs / Farbe / colores

- [BIAN] B standard
T + 10%
S + 20%
- [RAL] S + 20%
RAL non inclusi in tabella
special Ral colours
couleurs Ral spéciales
RAL Farbe nicht in der Tabelle inbegriffen
colores RAL especiales

Kcal = Watt x 0,860
BTU = Watt x 3,413

Watt Δt 60°= Watt Δt 50° x 1,264
Watt Δt 40°= Watt Δt 50° x 0,750
Watt Δt 30°= Watt Δt 50° x 0,518
Watt Δt 20°= Watt Δt 50° x 0,307

p max = 10.0 bar

ANTRAX IT SRL
Via BOSCALTO 40
31023 RESANA TV - ITALY
TEL. +39 0423 7174
FAX +39 0423 717474
WWW.ANTRAX.IT
ANTRAX@ANTRAX.IT

